

PROMOTIONS AND NOVELTIES  
*PROMOZIONI E NOVITÀ*  
**2023**



**TREES**



**TRΞS**

PROMOTIONS AND NOVELTIES  
*PROMOZIONI E NOVITÀ*

**2023**



## SPECIAL PROMOTIONS

### **6** *PROMOZIONI SPECIALI*

- 7 Selection Mix
- 11 Exclusive Mix
- 14 Therm-box / Rapid-box
- 15 Box

## SHOWER ROOM NOVELTIES

### **18** *NOVITÀ PER LO SPAZIO DOCCIA*

- 20 Over-wall
- 32 B-system
- 36 Therm-box
- 40 Shower technology

## NEW COLLECTIONS

### **44** *NUOVE COLLEZIONI*

- 46 Mont Blanc
- 50 Fuji

# SPECIAL PROMOTIONS

## PROMOZIONI SPECIALI

- Promotion valid until **31/12/2023** (or while stocks last).
- Promotion only valid for the purchase of the products on promotion.
- This promotion cannot be combined with any other existing promotions.
  
- *Promozione valida fino al **31/12/2023** (o fino a fine scorte).*
- *Promozione valida solo per l'acquisto dei prodotti citati.*
- *Questa promozione non è accumulabile con altre promozioni in corso.*

# SELECTION MIX

Purchase 1 washbasin from your favorite collection in our Selection range (Loft, Fuji, Project-tres, Max, Lex-Alp or Class) and combine it with any of the 4 different shower options you choose, and receive an **additional 15% discount**.

*Acquista 1 lavabo della tua collezione preferita della nostra gamma Selection (Loft, Fuji, Project-tres, Max, Lex-Alp o Class) e combinalo con una delle 4 diverse opzioni di doccia che scegli, **ottenendo uno sconto aggiuntivo del 15%**.*

-15%

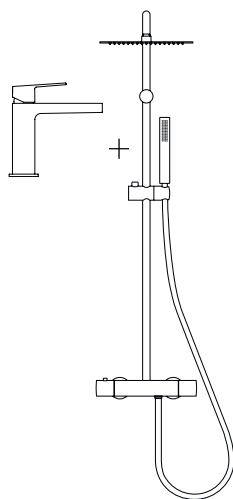

Washbasin / Lavabo  
+  
Over-wall

-15%

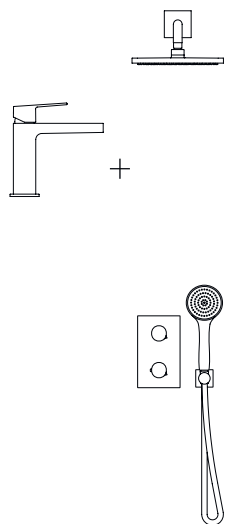

Washbasin / Lavabo  
+  
Therm-box

-15%

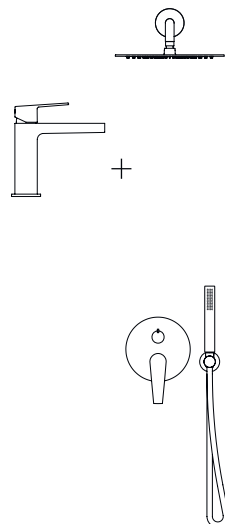

Washbasin / Lavabo  
+  
Rapid-box

-15%

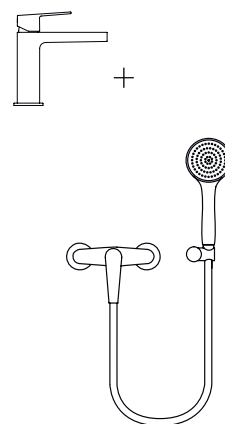

Washbasin / Lavabo  
+  
Shower / Doccia

Loft



+

			
20079604 <del>688.-</del> <b>584,8.-</b>	20079802 <del>671.-</del> <b>570,35.-</b>	20079404 <del>607.-</del> <b>515,95.-</b>	20079104 <del>360.-</del> <b>306.-</b>

Fuji



+

			
28179601 <del>678.-</del> <b>576,3.-</b>	28179801 <del>666.-</del> <b>566,1.-</b>	28179401 <del>561.-</del> <b>476,85.-</b>	28179101 <del>345.-</del> <b>293,25.-</b>

Project-tres



+

			
21179602 <del>669.-</del> <b>568,65.-</b>	21179804 <del>698.-</del> <b>593,3.-</b>	21179402 <del>643.-</del> <b>546,55.-</b>	21179202 <del>346.-</del> <b>294,1.-</b>



Loft



+



20079604NM ~~1067,-~~  
**906,95.-**



20079802NM ~~1040,-~~  
**884.-**



20079104NM ~~558,-~~  
**474,3.-**

Fuji



+



28179601NM ~~1051,-~~  
**893,35.-**



28179801NM ~~1032,-~~  
**877,2.-**



28179401NM ~~869,-~~  
**738,65.-**



28179101NM ~~535,-~~  
**454,75.-**

Project-tres



+



21179602NM ~~1037,-~~  
**881,45.-**



21179804NM ~~1082,-~~  
**919,7.-**



21179402NM ~~996,-~~  
**846,6.-**





21179202NM ~~536,-~~  
**455,6.-**

Max



+

			
6279602 <del>587,-</del> <b>498,95.-</b>	6279801 <del>509,-</del> <b>432,65.-</b>	06279402 <del>468,-</del> <b>397,8.-</b>	06279102 <del>309,-</del> <b>262,65.-</b>

Lex-Alp





+

			
181 796 02 <del>587,-</del> <b>498,95.-</b>	181 798 02 <del>509,-</del> <b>432,65.-</b>	181 794 02 <del>499,-</del> <b>424,15.-</b>	181 791 02 <del>269,-</del> <b>228,65.-</b>

Class



+

			
205 796 04 <del>585,-</del> <b>497,25.-</b>	205 798 01 <del>507,-</del> <b>430,95.-</b>	205 794 04 <del>521,-</del> <b>442,85.-</b>	205 791 04 <del>232,-</del> <b>197,2.-</b>

# EXCLUSIVE MIX

Purchase 1 washbasin from your favorite collection in our Exclusive range (Slim, Study or Cuadro) and combine it with any of the 4 different shower options you choose, and receive an **additional 15% discount**.

*Acquista 1 lavabo della tua collezione preferita della nostra gamma Exclusive (Slim, Study o Cuadro) e combinalo con una delle 4 diverse opzioni di doccia che scegli, **ottenendo uno sconto aggiuntivo del 15%**.*

-15%

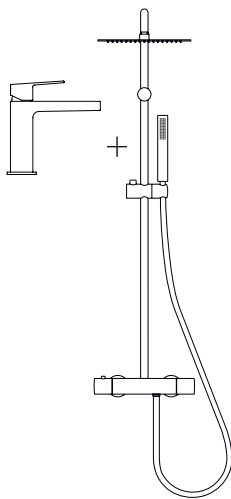

Washbasin / Lavabo  
+  
Over-wall

-15%

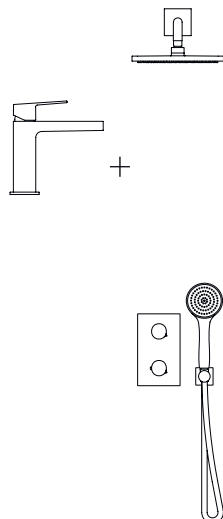

Washbasin / Lavabo  
+  
Therm-box

-15%

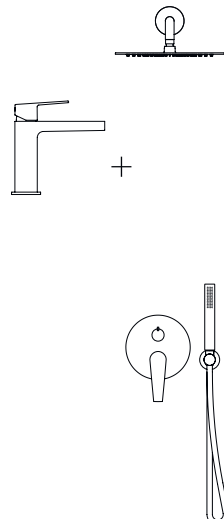

Washbasin / Lavabo  
+  
Rapid-box

-15%

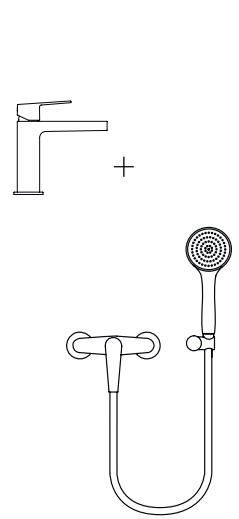

Washbasin / Lavabo  
+  
Shower / Doccia

Slim



+



20279601 ~~779,-~~  
**662,15,-**



20279801 ~~776,-~~  
**659,6,-**



20279401 ~~783,-~~  
**665,55,-**



20279102 ~~512,-~~  
**435,2,-**

Study



+



26279602 ~~728,-~~  
**618,8,-**



26279802 ~~736,-~~  
**625,6,-**



26279402 ~~641,-~~  
**544,85,-**



26279102 ~~430,-~~  
**365,5,-**

Cuadro



+



00679602 ~~846,-~~  
**719,1,-**



00679802 ~~758,-~~  
**644,3,-**



00679402 ~~719,-~~  
**611,15,-**



00679102 ~~453,-~~  
**385,05,-**

## Slim



+



20279601NM ~~1207,-~~  
**1025,95.-**



20279801NM ~~1203,-~~  
**1022,55.-**



20279401NM ~~1213,-~~  
**1031,05.-**



20279102NM ~~793,-~~  
**674,05.-**

## Study



+



26279602NM ~~1129,-~~  
**959,65.-**



26279802NM ~~1141,-~~  
**969,85.-**



26279402NM ~~994,-~~  
**844,9.-**



26279102NM ~~667,-~~  
**566,95.-**

## Cuadro



+



00679602NM ~~1311,-~~  
**1114,35.-**



00679802NM ~~1175,-~~  
**998,75.-**



00679402NM ~~1114,-~~  
**946,9.-**



00679102NM ~~702,-~~  
**596,7.-**

# THERM-BOX | RAPID-BOX

Buy the concealed shower units now (including free units depending on the quantity) and buy the exposed part of the taps later on to simplify installation planning and increase efficiency.

*Acquista prima le scatole da incasso per doccia (con unità gratuite a seconda della quantità), poi la parte visibile della rubinetteria, semplificando in questo modo la pianificazione dei lavori e aumentando l'efficienza.*

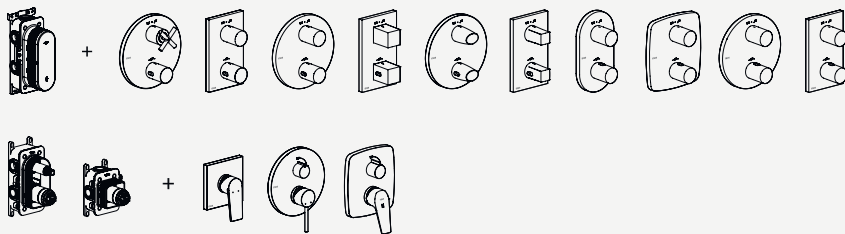

**THERM-BOX (2V)**



20785001    130.-

For 11 units or more  
A partire da 11 unità  
**1 for free/gratis**

For 20 units or more  
A partire da 20 unità  
**2 for free/gratis**

Example: Buying 11 units, you only pay 10.  
For 20 units, you only pay 18.

*Esempio: comprando 11 unità, solo pagherá 10. Per 20 unità solo pagherá 18.*

**RAPID-BOX (1V)**



20827810    80.-

For 12 units or more  
A partire da 12 unità  
**2 for free/gratis**

Example: Buying 12 units, you only pay 10.  
*Esempio: comprando 12 unità, solo pagherá 10.*

**RAPID-BOX (2V)**



20828110    90.-

For 12 units or more  
A partire da 12 unità  
**2 for free/gratis**

Example: Buying 12 units, you only pay 10.  
*Esempio: comprando 12 unità, solo pagherá 10.*



## BOX

Discover the BOX promotion in which you can find self-service boxes in a variety of designs to meet your needs.

*Scopri la promozione BOX dove puoi trovare numerose configurazioni di box self-service che si adattano alle tue esigenze.*



Tres Box are self-service boxes containing our most popular products, so you can display them all in the same store, accompanied by suitable packaging to capture the attention of customers.

*Le Box di Tres sono scatole self-service di prodotti di uso frequente da esibire nel punto vendita con una confezione adeguata e attrattiva per i clienti.*



These products can also be purchased in generic packaging without a dispenser box, so you can just take advantage of the bulk discount and simply place them on shelves in store or put them in the warehouse.



*Questi prodotti possono essere acquistati con una confezione generica e senza scatola dispenser, collocati sugli scaffali del negozio o del magazzino, e approfittare dell'offerta di acquisto di quantitativi elevati.*



5 x 190 387 01

Over-wall





 19038701BX	<del>2415.-</del>
 19038701P	<b>2174.-</b>

5 x 216 395 21

Base Plus





 21639521BX	<del>2180.-</del>
 21639521P	<b>1962.-</b>

5 x 190 393 01

Over-wall





 19039301BX	<del>2055.-</del>
 19039301P	<b>1850.-</b>

6 x 216 393 01

Base Plus





 21639301BX	<del>2016.-</del>
 21639301P	<b>1814.-</b>

8 x 190 196 01

Over-wall





 19019601BX	<del>1576.-</del>
 19019601P	<b>1418.-</b>

5 x 215 250 04

Therm-box





 21525004BX	<del>2275.-</del>
 21525004P	<b>2048.-</b>

5 x 216 250 04

Therm-box





 21625004BX	<del>2025.-</del>
 21625004P	<b>1823.-</b>

5 x 216 312 21

Base Plus





 21631221BX	<del>2195.-</del>
 21631221P	<b>1976.-</b>

6 x 216 191 10

Base Plus





 21619110BX	<del>1854.-</del>
 21619110P	<b>1669.-</b>

5 x 204 280 04

Rapid-box





 20428004BX	<del>1785.-</del>
 20428004P	<b>1607.-</b>

6 x 161 475

Shower



 161475BX	<del>1470.-</del>
 161475P	<b>1323.-</b>





6 x 216 164 01

Base Plus



21616401BX	<del>810.-</del>
21616401P	<b>729.-</b>

6 x 216 164 09

Base Plus



21616409BX	<del>810.-</del>
21616409P	<b>729.-</b>

6 x 218 103 01

Canigó Plus



21810301BX	<del>492.-</del>
21810301P	<b>443.-</b>

6 x 139 441

Kitchen



139441BX	<del>492.-</del>
139441P	<b>443.-</b>

15 x 134 540 10

Complements



13454010BX	<del>363.-</del>
13454010P	<b>327.-</b>

9 x 134 634 10

Complements



13463410BX	<del>369.-</del>
13463410P	<b>332.-</b>

6 x 134 215 024

Complements



134215024BX	<del>894.-</del>
134215024P	<b>729.-</b>

12 x 91 34 609

Shower



9134609BX	<del>276.-</del>
9134609P	<b>248.-</b>

12 x 91 34 828

Shower



9134828BX	<del>213,6.-</del>
9134828P	<b>192.-</b>



5 x 299 749 05

Shower



29974905BX	<del>170.-</del>
29974905P	<b>153.-</b>

SHOWER ROOM  
NOVELTIES

*NOVITÀ PER LO  
SPAZIO DOCCIA*



## OVER-WALL

Thermostatic wall kits  
**Novelty: more options available.**

*Kit termostatici a muro.  
 Novità: più varianti disponibili.*



## B-SYSTEM

Concealed thermostatic kits with 2, 3 or 4 outlets.

*Kit termostatici da incasso a 2, 3 o 4 getti.*

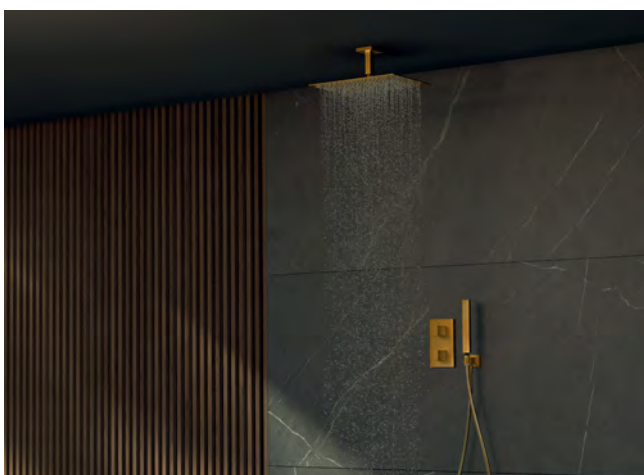

## THERM-BOX

Concealed thermostatic kits with 2 outlets.

*Kit termostatici da incasso a 2 getti.*



## SHOWER TECHNOLOGY

Electronic thermostatic kits with 2,3 or 4 outlets.

*Kit termostatici elettronici da incasso a 2, 3 o 4 getti.*

# OVER-WALL



The Over-wall thermostatic collection includes all the surface-mounted thermostatic taps from Tres. With various different designs that can be adapted to all spaces, offering total temperature control and everything you need to enjoy a pleasant shower. The Over-wall thermostatic sets are the perfect solution to update your shower without major building work and with the best technology.

*La collezione termostatica Over-wall riunisce tutti i rubinetti termostatici da appoggio di Tres. Con diversi modelli per adattarsi a tutti gli ambienti, offrono un controllo totale della temperatura e tutte le caratteristiche per una doccia piacevole. I gruppi doccia termostatici Over-wall sono la soluzione per aggiornare la tua doccia senza grandi ristrutturazioni e con la migliore tecnologia.*



Temperature control with a safety push button that limits the temperature to 38°C.

*Controllo della temperatura con pulsante di sicurezza che limita la temperatura a 38°C.*



Inverter built into the flow rate regulator control for 2 and 3 outlets.

*Deviatore integrato nella manopola è presente un regolatore di flusso, sia per 2 che per 3 vie.*



Telescopic bar, allowing the shower head height to be adjusted to suit each need.

*Barra telescopica che consente di definire l'altezza del soffione, secondo le necessità.*

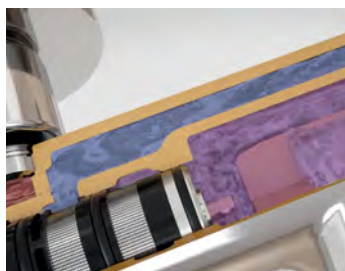

#### Touch-cool

The internal water circuit makes the cold water come in contact with the surface, meaning the tap stays cool when touched and preventing burns.

*Il circuito interno dell'acqua fa in modo che sia l'acqua fredda a toccare la superficie e in questo modo il rubinetto rimane sempre freddo al tatto, evitando bruciate.*



#### Easy-clean

Tres offers the possibility of cleaning the cartridge easily in the event of blockage, without losing its calibration.

*Tres offre la possibilità di pulire facilmente la cartuccia in caso di ingorgo senza perderne la calibratura.*



#### Instant 77

The cartridge ensures a constant flow of water at the desired temperature  $\pm 1$  degree, in spite of pressure and/or temperature changes. Designed for Legionella disinfection.

*La cartuccia assicura una portata d'acqua costante alla temperatura desiderata di  $\pm 1$  grado in caso di variazioni di pressione e/o temperatura. Concepita per la disinfezione dalla legionella.*



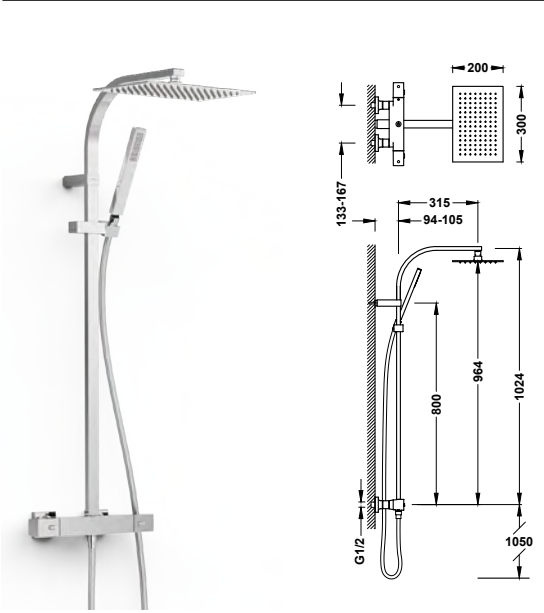

**2-way wall-mounted thermostatic shower mixer tap set**

- With inverter integrated into the flow regulator.
- Square handle.
- Stainless steel adjustable shower head: 300x200 mm.
- Adjustable and sliding support for hand shower.
- Anti-limescale brass hand shower.
- Satin hose.

■	19039306	691.-
■	19039306NM	1071.-
■	19039306BM	1071.-
■	19039306AC	1071.-
■	19039306OM	1382.-

**Set di miscelatore termostatico a muro 2 getti per doccia**

- Con inverter incorporato nel regolatore di flusso.
- Manopola quadrata.
- Soffione doccia orientabile in acciaio inossidabile: 300x200 mm.
- Supporto scorrevole e orientabile per doccia.
- Doccino anticalcare in ottone.
- Flessibile satinato.

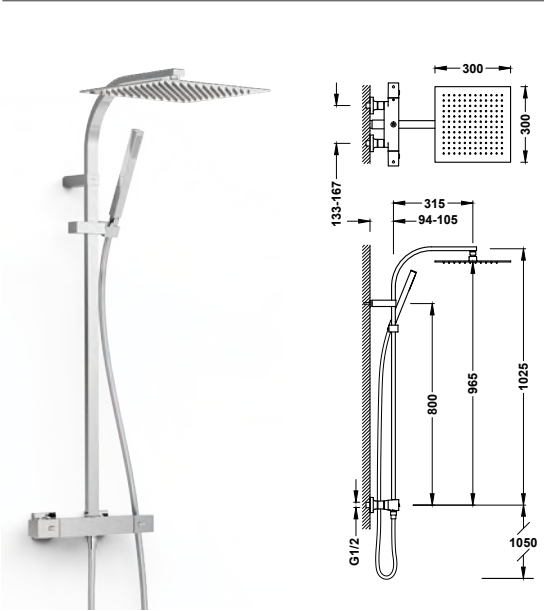

**2-way wall-mounted thermostatic shower mixer tap set**

- With inverter integrated into the flow regulator.
- Square handle.
- Stainless steel adjustable shower head: Ø250 mm.
- Adjustable and sliding support for hand shower.
- Anti-limescale brass hand shower.
- Satin hose.

■	19039308	589.-
■	19039308NM	913.-
■	19039308BM	913.-
■	19039308AC	913.-
■	19039308OM	1178.-

**Set di miscelatore termostatico a muro 2 getti per doccia**

- Con inverter incorporato nel regolatore di flusso.
- Manopola quadrata.
- Soffione doccia orientabile in acciaio inossidabile: Ø250 mm.
- Supporto scorrevole e orientabile per doccia.
- Doccino anticalcare in ottone.
- Flessibile satinato.

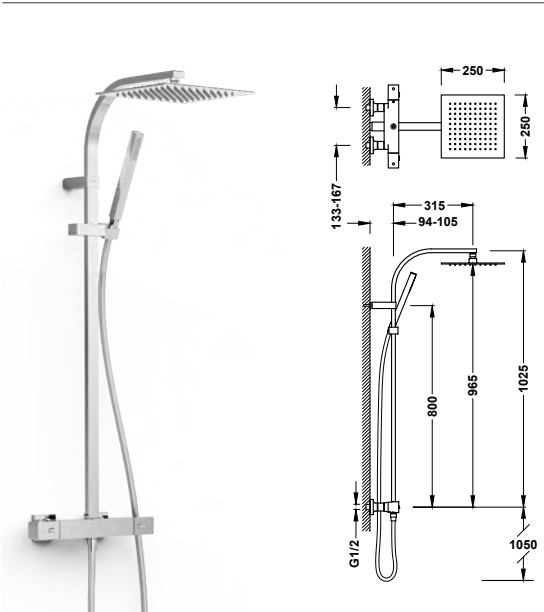

**2-way wall-mounted thermostatic shower mixer tap set**

- With inverter integrated into the flow regulator.
- Square handle.
- Stainless steel adjustable shower head: 250x250 mm.
- Adjustable and sliding support for hand shower.
- Anti-limescale brass hand shower.
- Satin hose.

■	19039310	567.-
---	----------	-------

**Set di miscelatore termostatico a muro 2 getti per doccia**

- Con inverter incorporato nel regolatore di flusso.
- Manopola quadrata.
- Soffione doccia orientabile in acciaio inossidabile: 250x250 mm.
- Supporto scorrevole e orientabile per doccia.
- Doccino anticalcare in ottone.
- Flessibile satinato.



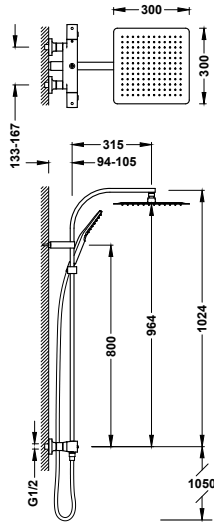

### 2-way wall-mounted thermostatic shower mixer tap set

19039309

567.-

- With inverter integrated into the flow regulator.
- Square handle.
- Stainless steel adjustable shower head: 300x300 mm.
- Adjustable and sliding support for hand shower.
- Anti-limescale hand showers: 96x110 mm. (3 stream types).
- Satin hose.

### Set di miscelatore termostatico a muro 2 getti per doccia

- Con inverter incorporato nel regolatore di flusso.
- Manopola quadrata.
- Soffione doccia orientabile in acciaio inossidabile: 300x300 mm.
- Supporto scorrevole e orientabile per doccia.
- Doccino anticalcare: 96x110 mm. (3 tipi di getto).
- Flessibile satinato.

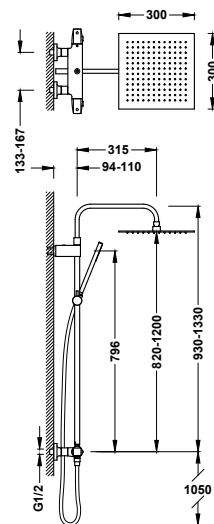

### 2-way wall-mounted thermostatic shower mixer tap set

19039307

598.-

- With inverter integrated into the flow regulator.
- Square-round handle.
- Telescopic shower bar.
- Stainless steel adjustable shower head: 300x300 mm.
- Adjustable and sliding support for hand shower.
- Anti-limescale brass hand shower.
- Satin hose.

### Set di miscelatore termostatico a muro 2 getti per doccia

- Con inverter incorporato nel regolatore di flusso.
- Manopola quadrata-rotonda.
- Colonna doccia telescopica.
- Soffione doccia orientabile in acciaio inossidabile: 300x300 mm.
- Supporto scorrevole e orientabile per doccia.
- Doccino anticalcare in ottone.
- Flessibile satinato.

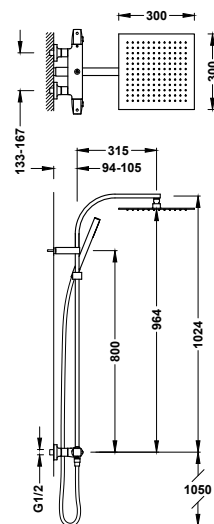
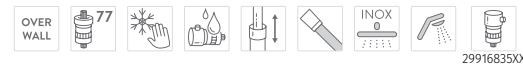

### 2-way wall-mounted thermostatic shower mixer tap set

19039305

595.-

- With inverter integrated into the flow regulator.
- Square-round handle.
- Stainless steel adjustable shower head: 300x300 mm.
- Adjustable and sliding support for hand shower.
- Anti-limescale brass hand shower.
- Satin hose.

### Set di miscelatore termostatico a muro 2 getti per doccia

- Con inverter incorporato nel regolatore di flusso.
- Manopola quadrata-rotonda.
- Soffione doccia orientabile in acciaio inossidabile: 300x300 mm.
- Supporto scorrevole e orientabile per doccia.
- Doccino anticalcare in ottone.
- Flessibile satinato.



19039307NM	927.-
19039307BM	927.-
19039307AC	927.-
19039307KMB	927.-
19039307OM	1196.-
19039307OPM	1196.-

19039305NM	922.-
19039305BM	922.-
19039305AC	922.-
19039305KMB	922.-
19039305OM	1190.-
19039305OPM	1190.-

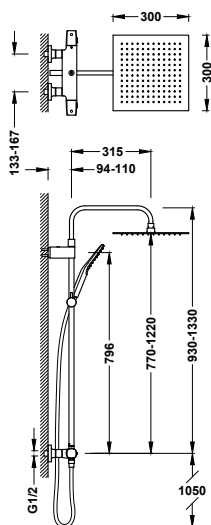

**2-way wall-mounted thermostatic shower mixer tap set**

- With inverter integrated into the flow regulator.
- Handle with rounded edges.
- Telescopic shower bar.
- Stainless steel adjustable shower head: 300x300 mm.
- Adjustable and sliding support for hand shower.
- Anti-limescale hand showers: 96x110 mm. (3 stream types).
- Satin hose.

19038702	592.-
19038702NM	918.-
19038702BM	918.-
19038702AC	918.-
19038702KMB	918.-
19038702OM	1184.-
19038702OPM	1184.-

**Set di miscelatore termostatico a muro 2 getti per doccia**

- Con inverter incorporato nel regolatore di flusso.
- Manopola con bordi arrotondati.
- Colonna doccia telescopica.
- Soffione doccia orientabile in acciaio inossidabile: 300x300 mm.
- Supporto scorrevole e orientabile per doccia.
- Doccino anticalcare: 96x110 mm. (3 tipi di getto).
- Flessibile satinato.

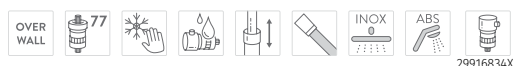

29916834XX

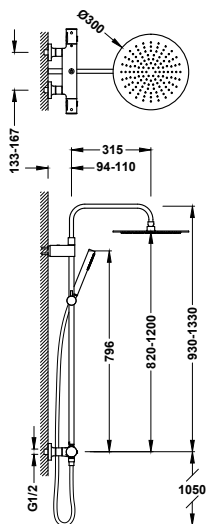

**2-way wall-mounted thermostatic shower mixer tap set**

- With inverter integrated into the flow regulator.
- Round handle.
- Telescopic shower bar.
- Stainless steel adjustable shower head: Ø 300 mm.
- Adjustable and sliding support for hand shower.
- Anti-limescale brass hand shower.
- Satin hose.

19039302	563.-
19039302NM	873.-
19039302BM	873.-
19039302AC	873.-
19039302KMB	873.-
19039302OM	1126.-
19039302OPM	1126.-

**Set di miscelatore termostatico a muro 2 getti per doccia**

- Con inverter incorporato nel regolatore di flusso.
- Manopola rotonda.
- Colonna doccia telescopica.
- Soffione doccia orientabile in acciaio inossidabile: Ø 300 mm.
- Supporto scorrevole e orientabile per doccia.
- Doccino anticalcare in ottone.
- Flessibile satinato.

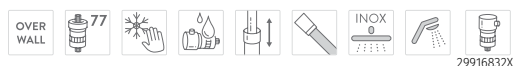

29916832XX

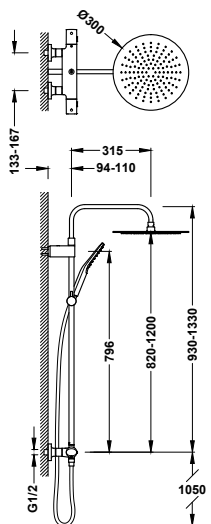

**2-way wall-mounted thermostatic shower mixer tap set**

- With inverter integrated into the flow regulator.
- Oval handle.
- Telescopic shower bar.
- Stainless steel adjustable shower head: Ø 300 mm.
- Adjustable and sliding support for hand shower.
- Anti-limescale hand showers: Ø 110 mm. (3 stream types).
- Satin hose.

19038705	563.-
19038705NM	873.-
19038705BM	873.-
19038705AC	873.-
19038705KMB	873.-
19038705OM	1126.-
19038705OPM	1126.-

**Set di miscelatore termostatico a muro 2 getti per doccia**

- Con inverter incorporato nel regolatore di flusso.
- Manopola ovale.
- Colonna doccia telescopica.
- Soffione doccia orientabile in acciaio inossidabile: Ø 300 mm.
- Supporto scorrevole e orientabile per doccia.
- Doccino anticalcare: Ø 110 mm. (3 tipi di getto).
- Flessibile satinato.

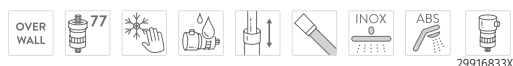

29916833XX



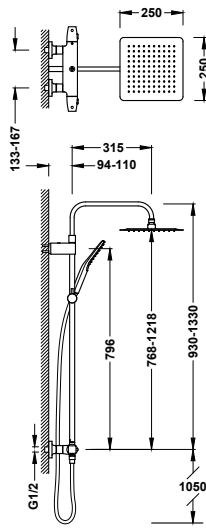

### 2-way wall-mounted thermostatic shower mixer tap set

19038706

555.-

- With inverter integrated into the flow regulator.
- Square-round handle.
- Telescopic shower bar.
- Stainless steel adjustable shower head: 250x250 mm.
- Adjustable and sliding support for hand shower.
- Anti-limescale hand showers: 96x110 mm. (3 stream types).
- Satin hose.

### Set di miscelatore termostatico a muro 2 getti per doccia

- Con inverter incorporato nel regolatore di flusso.
- Manopola quadrata-rotonda.
- Colonna doccia telescopica.
- Soffione doccia orientabile in acciaio inossidabile: 250x250 mm.
- Supporto scorrevole e orientabile per doccino.
- Doccino anticalcare: 96x110 mm. (3 tipi di getto).
- Flessibile satinato.

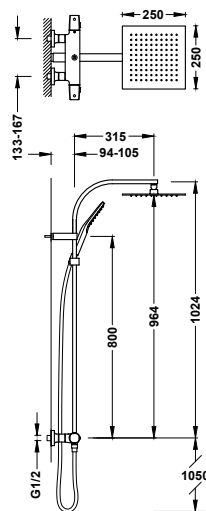

### 2-way wall-mounted thermostatic shower mixer tap set

19039311

522.-

- With inverter integrated into the flow regulator.
- Handle with rounded edges.
- Stainless steel adjustable shower head: 250x250 mm.
- Adjustable and sliding support for hand shower.
- Anti-limescale hand showers: 96x110 mm. (3 stream types).
- Satin hose.

### Set di miscelatore termostatico a muro 2 getti per doccia

- Con inverter incorporato nel regolatore di flusso.
- Manopola con bordi arrotondati.
- Soffione doccia orientabile in acciaio inossidabile: 250x250 mm.
- Supporto scorrevole e orientabile per doccino.
- Doccino anticalcare: 96x110 mm. (3 tipi di getto).
- Flessibile satinato.

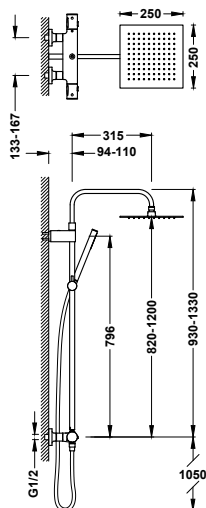

### 2-way wall-mounted thermostatic shower mixer tap set

19038709

513.-

- With inverter integrated into the flow regulator.
- Telescopic shower bar.
- Round handle.
- Stainless steel adjustable shower head: 250x250 mm.
- Adjustable and sliding support for hand shower.
- Anti-limescale brass hand shower.
- Satin hose.

### Set di miscelatore termostatico a muro 2 getti per doccia

- Con inverter incorporato nel regolatore di flusso.
- Colonna doccia telescopica.
- Manopola rotonda.
- Soffione doccia orientabile in acciaio inossidabile: 250x250 mm.
- Supporto scorrevole e orientabile per doccino.
- Doccino anticalcare in ottone.
- Flessibile satinato.



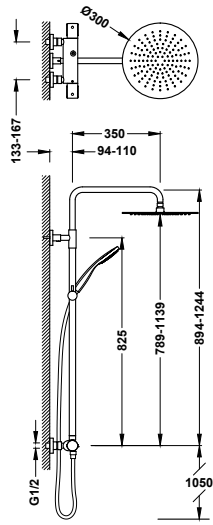

**2-way wall-mounted thermostatic shower mixer tap set**

- With inverter integrated into the flow regulator.
- ABS round handle.
- Telescopic shower bar.
- Stainless steel adjustable shower head: Ø 300 mm.
- Adjustable and sliding support for hand shower.
- Anti-limescale hand shower.
- Metal hose.

	19038701	483.-
	19038701NM	749.-

**Set di miscelatore termostatico a muro 2 getti per doccia**

- Con inverter incorporato nel regolatore di flusso.
- Manopola rotonda in ABS.
- Colonna doccia telescopica.
- Soffione doccia orientabile in acciaio inossidabile: Ø 300 mm.
- Supporto scorrevole e orientabile per doccia.
- Doccino anticalcare.
- Flessibile in metallo.

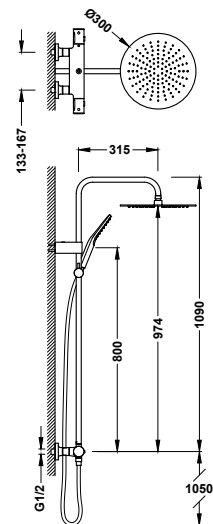
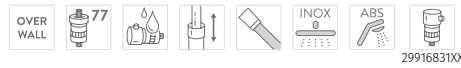

**2-way wall-mounted thermostatic shower mixer tap set**

- With inverter integrated into the flow regulator.
- Round handle.
- Stainless steel adjustable shower head: Ø300 mm.
- Adjustable and sliding support for hand shower.
- Anti-limescale hand showers: Ø110 mm. (3 stream types).
- Satin hose.

	19039314	479.-
	19039314NM	743.-
	19039314BM	743.-
	19039314AC	743.-
	19039314KMB	743.-
	19039314OM	958.-
	19039314OPM	958.-

**Set di miscelatore termostatico a muro 2 getti per doccia**

- Con inverter incorporato nel regolatore di flusso.
- Manopola rotonda.
- Soffione doccia orientabile in acciaio inossidabile: Ø300 mm.
- Supporto scorrevole e orientabile per doccia.
- Doccino anticalcare: Ø110 mm. (3 tipi di getto).
- Flessibile satinato.

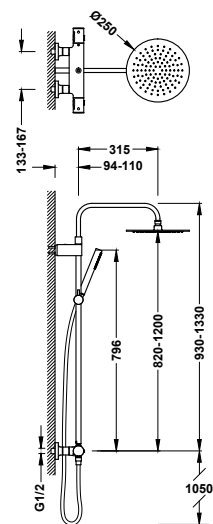

**2-way wall-mounted thermostatic shower mixer tap set**

- With inverter integrated into the flow regulator.
- Telescopic shower bar.
- Round handle.
- Stainless steel adjustable shower head: Ø250 mm.
- Adjustable and sliding support for hand shower.
- Anti-limescale brass hand shower.
- Satin hose.

	19038708	466.-
--	----------	-------

**Set di miscelatore termostatico a muro 2 getti per doccia**

- Con inverter incorporato nel regolatore di flusso.
- Colonna doccia telescopica.
- Manopola rotonda.
- Soffione doccia orientabile in acciaio inossidabile: Ø250 mm.
- Supporto scorrevole e orientabile per doccia.
- Doccino anticalcare in ottone.
- Flessibile satinato.



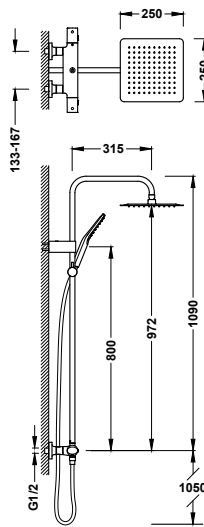

### 2-way wall-mounted thermostatic shower mixer tap set

19039313

463.-

- With inverter integrated into the flow regulator.
- Oval handle.
- Stainless steel adjustable shower head: 250x250 mm.
- Adjustable and sliding support for hand shower.
- Anti-limescale hand showers: 96x110 mm. (3 stream types).
- Satin hose.

### Set di miscelatore termostatico a muro 2 getti per doccia

- Con inverter incorporato nel regolatore di flusso.
- Manopola ovale.
- Soffione doccia orientabile in acciaio inossidabile: 250x250 mm.
- Supporto scorrevole e orientabile per doccino.
- Doccino anticalcare: 96x110 mm. (3 tipi di getto).
- Flessibile satinato.

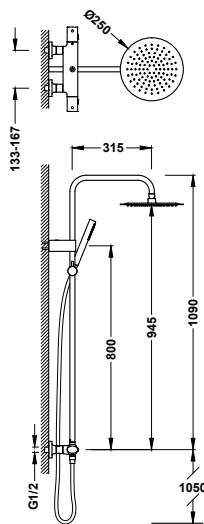

### 2-way wall-mounted thermostatic shower mixer tap set

19039312

443.-

- With inverter integrated into the flow regulator.
- Oval handle.
- Stainless steel adjustable shower head: Ø250 mm.
- Adjustable and sliding support for hand shower.
- Anti-limescale brass hand shower.
- Satin hose.

### Set di miscelatore termostatico a muro 2 getti per doccia

- Con inverter incorporato nel regolatore di flusso.
- Manopola ovale.
- Soffione doccia orientabile in acciaio inossidabile: Ø250 mm.
- Supporto scorrevole e orientabile per doccino.
- Doccino anticalcare in ottone.
- Flessibile satinato.

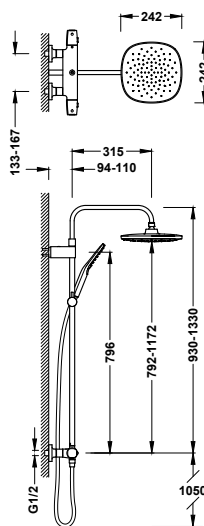

### 2-way wall-mounted thermostatic shower mixer tap set

19038707

414.-

- With inverter integrated into the flow regulator.
- Telescopic shower bar.
- Handle with rounded edges.
- Adjustable shower head: 242x242 mm.
- Adjustable and sliding support for hand shower.
- Anti-limescale hand showers: 120x120 mm. (3 stream types).
- Satin hose.

### Set di miscelatore termostatico a muro 2 getti per doccia

- Con inverter incorporato nel regolatore di flusso.
- Colonna doccia telescopica.
- Manopola con bordi arrotondati.
- Soffione doccia orientabile: 242x242 mm.
- Supporto scorrevole e orientabile per doccino.
- Doccino anticalcare: 120x120 mm. (3 tipi di getto).
- Flessibile satinato.



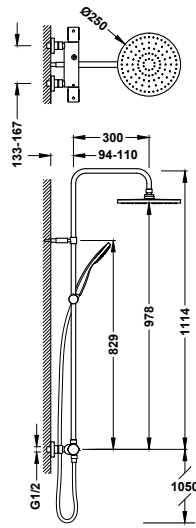

**2-way wall-mounted thermostatic shower mixer tap set**

19039301

411.-

19039301NM

637.-

- With inverter integrated into the flow regulator.
- ABS round handle.
- Adjustable shower head: Ø 250 mm.
- Adjustable and sliding support for hand shower.
- Anti-limescale hand showers: Ø 100 mm.
- Metal hose.

**Set di miscelatore termostatico a muro 2 getti per doccia**

- Con inverter incorporato nel regolatore di flusso.
- Manopola rotonda in ABS.
- Soffione doccia orientabile: Ø 250 mm.
- Supporto scorrevole e orientabile per doccia.
- Doccino anticalcare: Ø 100 mm.
- Flessibile in metallo.

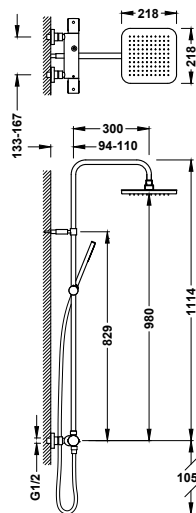

**2-way wall-mounted thermostatic shower mixer tap set**

19039318

406.-

- With inverter integrated into the flow regulator.
- ABS round handle.
- Adjustable shower head: 220x220 mm.
- Adjustable and sliding support for hand shower.
- Anti-limescale hand shower.
- Metal hose.

**Set di miscelatore termostatico a muro 2 getti per doccia**

- Con inverter incorporato nel regolatore di flusso.
- Manopola rotonda in ABS.
- Soffione doccia orientabile: 220x220 mm.
- Supporto scorrevole e orientabile per doccia.
- Doccino anticalcare
- Flessibile in metallo.

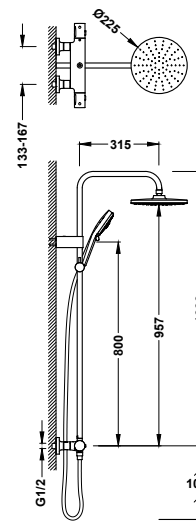

**2-way wall-mounted thermostatic shower mixer tap set**

19039315

379.-

- With inverter integrated into the flow regulator.
- Round handle.
- Adjustable shower head: Ø 225 mm. Self-cleaning anti-limescale nozzles
- Adjustable and sliding support for hand shower.
- Anti-limescale hand showers: Ø110 mm. (5 stream types). Self-cleaning anti-limescale nozzles
- Satin hose.

**Set di miscelatore termostatico a muro 2 getti per doccia**

- Con inverter incorporato nel regolatore di flusso.
- Manopola rotonda.
- Soffione doccia orientabile: Ø225 mm. Fori anticalcare autopulenti.
- Supporto scorrevole e orientabile per doccia.
- Doccino anticalcare: Ø110 mm. (5 tipi di getto). Fori anticalcare autopulenti.
- Flessibile satinato.



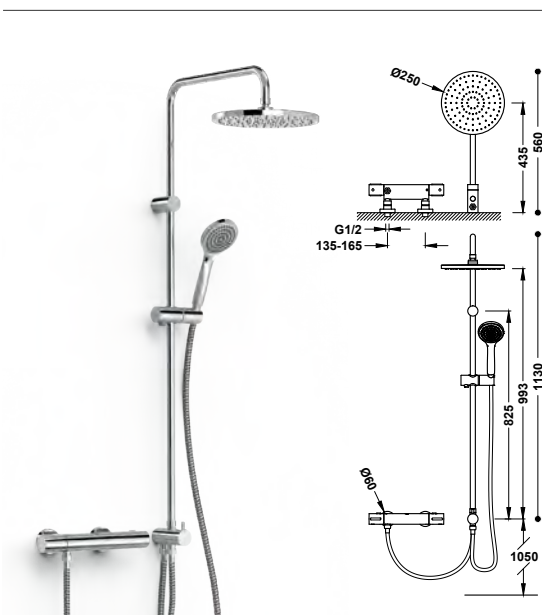

### 2-way wall-mounted thermostatic shower mixer tap set

19038501

368 .-

- With inverter integrated into the flow regulator.
- ABS round handle.
- Adjustable shower head: Ø 250 mm.
- Adjustable and sliding support for hand shower.
- Anti-limescale hand showers: Ø 100 mm.
- Metal hose.

### Set di miscelatore termostatico a muro 2 getti per doccia

- Con inverter incorporato nel regolatore di flusso.
- Manopola rotonda in ABS.
- Soffione doccia orientabile: Ø 250 mm.
- Supporto scorrevole e orientabile per doccino.
- Doccino anticalcare: Ø 100 mm.
- Flessibile in metallo.

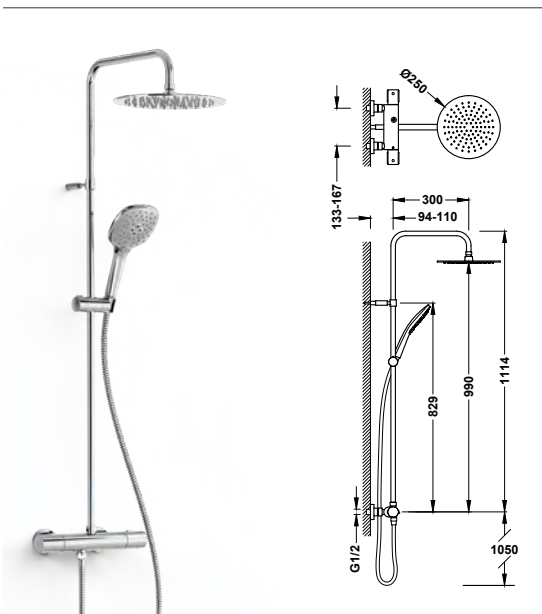
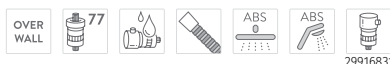

### 2-way wall-mounted thermostatic shower mixer tap set

19039316

358 .-

- With inverter integrated into the flow regulator.
- ABS round handle.
- Stainless steel adjustable shower head: Ø250 mm.
- Adjustable and sliding support for hand shower.
- Anti-limescale hand showers: 120x120 mm. (3 stream types).
- Metal hose.

### Set di miscelatore termostatico a muro 2 getti per doccia

- Con inverter incorporato nel regolatore di flusso.
- Manopola rotonda in ABS.
- Soffione doccia orientabile in acciaio inossidabile: Ø250 mm.
- Supporto scorrevole e orientabile per doccino.
- Doccino anticalcare: 120x120 mm. (3 tipi di getto).
- Flessibile in metallo.

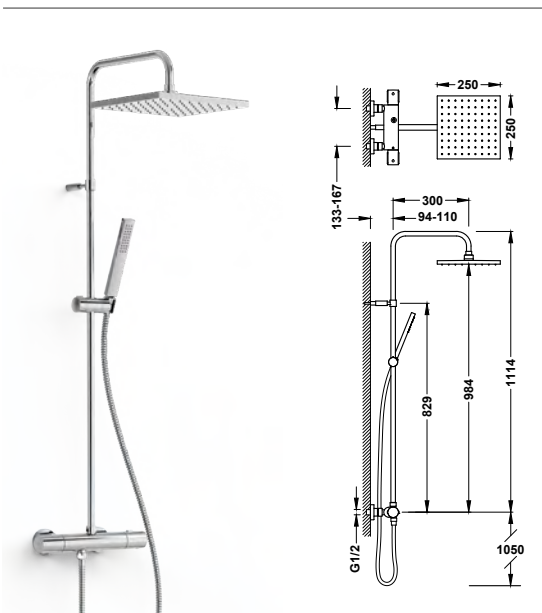

### 2-way wall-mounted thermostatic shower mixer tap set

19039317

340 .-

- With inverter integrated into the flow regulator.
- ABS round handle.
- Stainless steel adjustable shower head: 250x250 mm.
- Adjustable and sliding support for hand shower.
- Anti-limescale hand shower.
- Metal hose.

### Set di miscelatore termostatico a muro 2 getti per doccia

- Con inverter incorporato nel regolatore di flusso.
- Manopola rotonda in ABS.
- Soffione doccia orientabile: 250x250 mm.
- Supporto scorrevole e orientabile per doccino.
- Doccino anticalcare
- Flessibile in metallo.



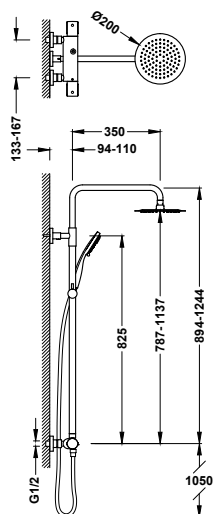

### 2-way wall-mounted thermostatic shower mixer tap set

19038710

323.-

- With inverter integrated into the flow regulator.
- Telescopic shower bar.
- ABS round handle.
- Stainless steel adjustable shower head: Ø200 mm.
- Adjustable and sliding support for hand shower.
- Anti-limescale hand showers: Ø100 mm. (3 stream types).
- Metal hose.

#### Set di miscelatore termostatico a muro 2 getti per doccia

- Con inverter incorporato nel regolatore di flusso.
- Colonna doccia telescopica.
- Manopola rotonda in ABS.
- Soffione doccia orientabile in acciaio inossidabile: Ø200 mm.
- Supporto scorrevole e orientabile per doccia.
- Doccino anticalcare: Ø100 mm. (3 tipi di getto).
- Flessibile in metallo.

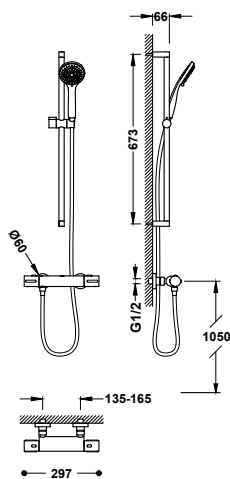

### Wall-mounted thermostatic shower mixer tap kit

19019601

197.-

- ABS round handle.
- Shower bar: length 673 mm and Ø 20.6 mm.
- Adjustable and sliding support for hand shower.
- Anti-limescale hand showers: Ø 100 mm. (3 stream types).
- Metal hose.

#### Kit di miscelatore termostatico a muro per doccia

- Manopola rotonda in ABS.
- Colonna doccia: lungh. 673 mm e Ø 20,6 mm.
- Supporto scorrevole e orientabile per doccia.
- Doccino anticalcare: Ø 100 mm. (3 tipi di getto).
- Flessibile in metallo.



29916831

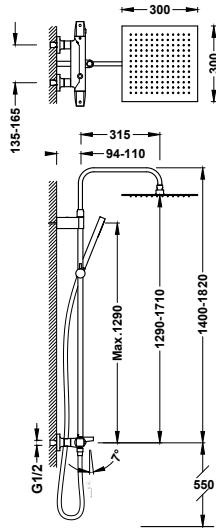

### 3-way wall-fitted thermostatic mixer tap set for bath and shower

- Inverter integrated into the flow regulator.
- Square-round handle.
- Telescopic shower bar.
- Stainless steel adjustable shower head: 300x300 mm.
- Adjustable and sliding support for hand shower.
- Anti-limescale brass hand shower.
- Satin hose.

### Set di miscelatore termostatico a muro 3 getti per vasca e doccia

- Inverter incorporato nel regolatore di flusso.
- Manopola quadrata-rotonda.
- Colonna doccia telescopica.
- Soffione doccia orientabile in acciaio inossidabile: 300x300 mm.
- Supporto scorrevole e orientabile per doccia.
- Doccino anticalcare in ottone.
- Flessibile satinato.



29916835XX

■	19031205	635 .-
■	19031205NM	984 .-
■	19031205BM	984 .-
■	19031205AC	984 .-
■	19031205KMB	984 .-
■	19031205OM	1270 .-
■	19031205OPM	1270 .-

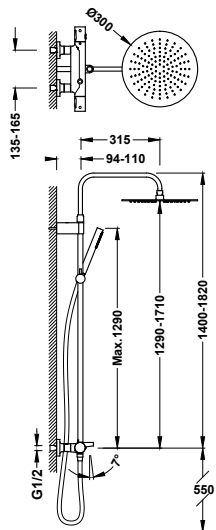

### 3-way wall-mounted thermostatic mixer tap set for bath and shower

- With inverter integrated into the flow regulator.
- Round handle.
- Telescopic shower bar.
- Stainless steel adjustable shower head: Ø 300 mm.
- Adjustable and sliding support for hand shower.
- Anti-limescale brass hand shower.
- Satin hose.

### Set di miscelatore termostatico a muro 3 getti per vasca e doccia

- Inverter incorporato nel regolatore di flusso.
- Manopola rotonda.
- Colonna doccia telescopica.
- Soffione doccia orientabile in acciaio inossidabile: Ø 300 mm.
- Supporto scorrevole e orientabile per doccia.
- Doccino anticalcare in ottone.
- Flessibile satinato.

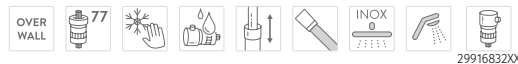

29916832XX

■	19031202	603 .-
■	19031202NM	935 .-
■	19031202BM	935 .-
■	19031202AC	935 .-
■	19031202KMB	935 .-
■	19031202OM	1206 .-
■	19031202OPM	1206 .-

# B-SYSTEM

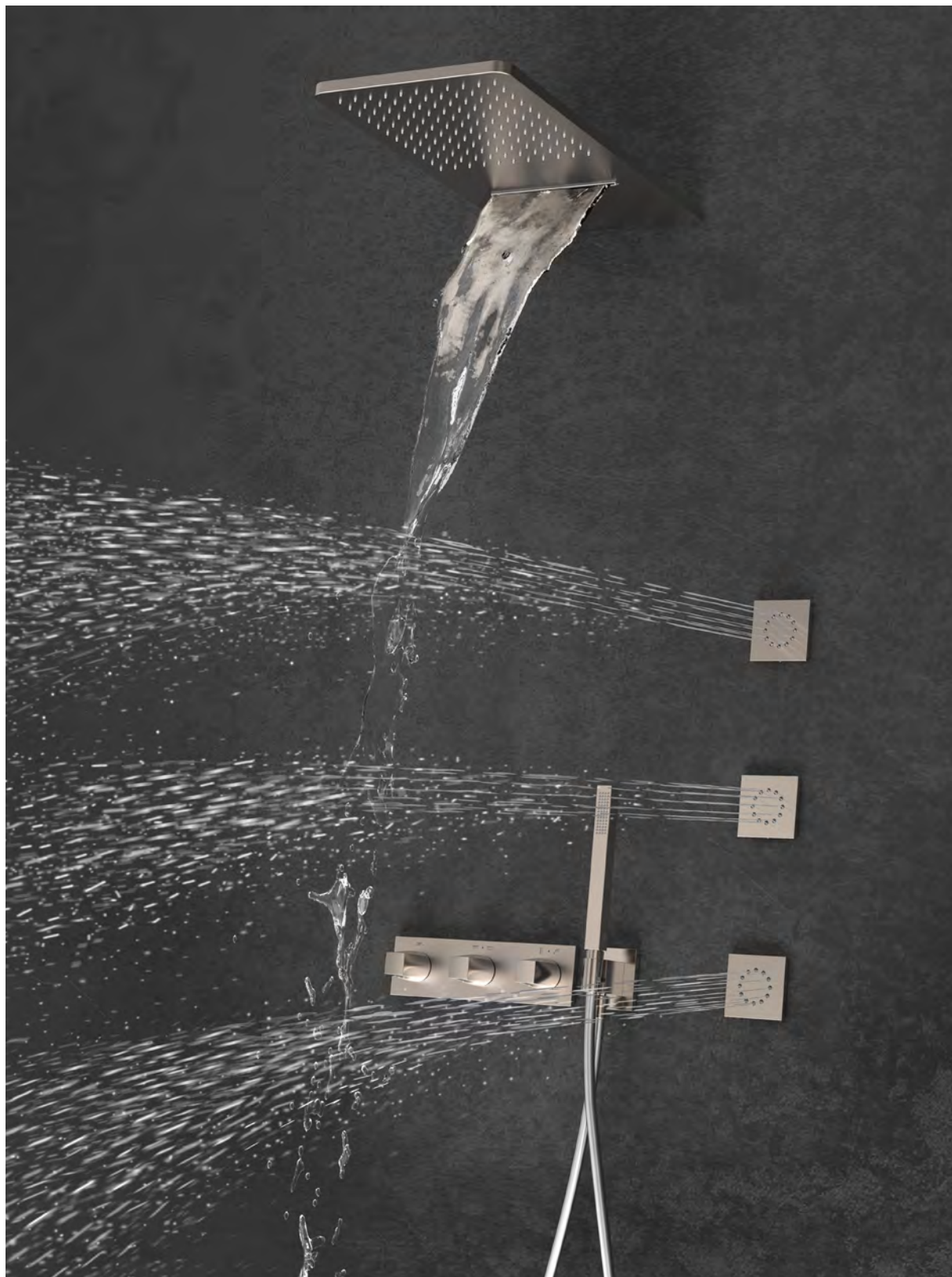



The B-system collection of concealed thermostats is characterised by its elegant and minimalist design, with a body slightly separated from the wall to give an impression of weightlessness. The concealed inner box allows for a cleaner and simpler installation. B-system provides elegance and convenience for your shower.

*La collezione di miscelatori termostatici a incasso B-system è caratterizzata da un design raffinato con linee sobrie e un corpo leggermente separato dalla parete per dare un senso di galleggiamento. La scatola interna a incasso permette un'installazione più pulita e più semplice. B-system è eleganza e comfort nella doccia.*

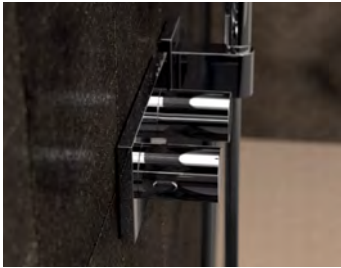

The shower rose is slightly separated from the wall to create a sense of flotation and to allow it to easily adapt to uneven walls.

*Il rosone è leggermente separato dal muro per dare una sensazione di galleggiamento e adattarsi facilmente alle pareti irregolari.*



Temperature control with a safety push button that limits the temperature to 38°C.

*Controllo della temperatura con pulsante di sicurezza che limita la temperatura a 38°C.*



From 2 to 4 water outlets. Change between the different water outlets by just turning the distributor.

*Da 2 a 4 uscite dell'acqua. Con una semplice rotazione del distributore è possibile passare da una all'altra uscita dell'acqua disponibili.*

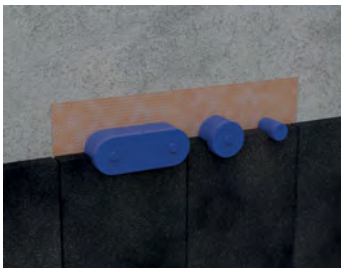

The concealed box insulates the brass body from heat transfer to the wall, and being watertight, prevents water from filtering through the wall in the event of a leak. The waterproof seal prevents damp.

*La scatola incassata isola la trasmissione di temperatura del corpo in ottone verso la parete. Essendo a tenuta stagna impedisce all'acqua di penetrare attraverso la parete in caso di perdite. La giunzione impermeabile previene l'umidità.*



The dampers prevent noise transmission from the tap to the wall and piping.

*Gli ammortizzatori impediscono la trasmissione del rumore del rubinetto alla parete e ai tubi.*



The cartridge ensures a constant flow of water at the desired temperature  $\pm 1$  degree, in spite of pressure and/or temperature changes. Designed for Legionella disinfection.

*La cartuccia assicura una portata d'acqua costante alla temperatura desiderata di  $\pm 1$  grado in caso di variazioni di pressione e/o temperatura. Concepita per la disinfezione dalla legionella.*





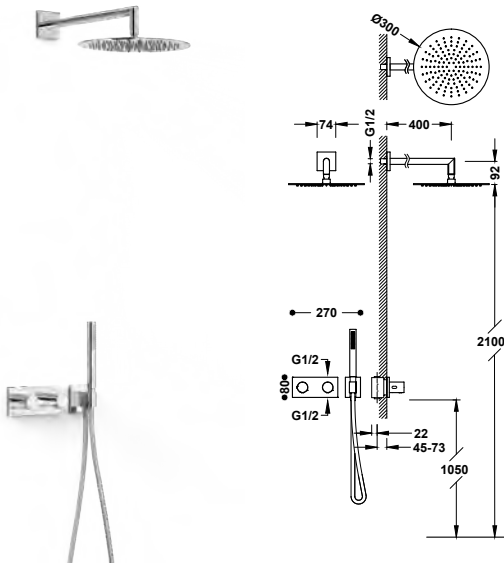

**B-system 2-way concealed thermostatic shower mixer tap kit**

- Concealed thermostatic body for horizontal installation included.
- Flow regulator and 2-way ceramic distributor.
- Round handle.
- Wall-mounted arm with adjustable stainless steel shower head: Ø 300 mm.
- Wall-mounted support for hand shower with water supply.
- Anti-limescale brass hand shower.
- Satin hose.

**Kit di miscelatore termostatico a incasso 2 getti B-system per doccia**

- Corpo termostatico a incasso con installazione orizzontale inclusa.
- Regolatore di flusso ed erogatore in ceramica a 2 getti.
- Manopola rotonda.
- Braccio a muro con soffione doccia orientabile in acciaio inossidabile: Ø 300 mm.
- Supporto per doccia con presa d'acqua a muro.
- Doccino anticalcare in ottone.
- Flessibile satinato.



30735204	803 .-
30735204NM	1245 .-
30735204AC	1245 .-
30735204OR	1606 .-
30735204OM	1606 .-
30735204OP	1606 .-
30735204OPM	1606 .-

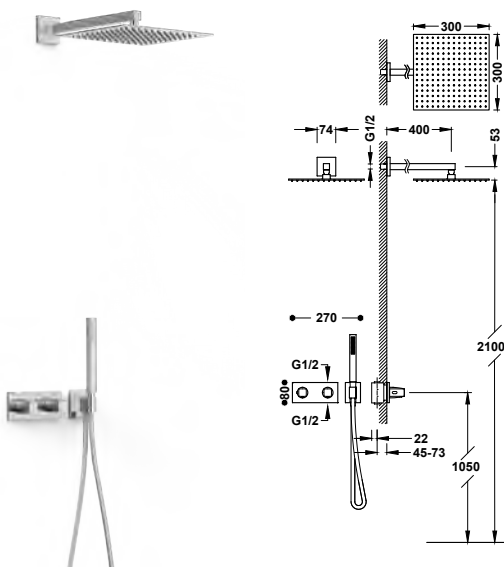

**B-system 2-way concealed thermostatic shower mixer tap kit**

- Concealed thermostatic body for horizontal installation included.
- Flow regulator and 2-way ceramic distributor.
- Square-round handle.
- Wall-mounted arm with adjustable brass shower head: 300x300 mm.
- Wall-mounted support for hand shower with water supply.
- Anti-limescale brass hand shower.
- Satin hose.

**Kit di miscelatore termostatico a incasso 2 getti B-system per doccia**

- Corpo termostatico a incasso con installazione orizzontale inclusa.
- Regolatore di flusso ed erogatore in ceramica a 2 getti.
- Manopola quadrata-rotonda.
- Braccio a muro con soffione doccia orientabile in acciaio inossidabile: 300x300 mm.
- Supporto per doccia con presa d'acqua a muro.
- Doccino anticalcare in ottone.
- Flessibile satinato.



30725204	859 .-
30725204NM	1331 .-
30725204AC	1331 .-
30725204OR	1718 .-
30725204OM	1718 .-
30725204OP	1718 .-
30725204OPM	1718 .-

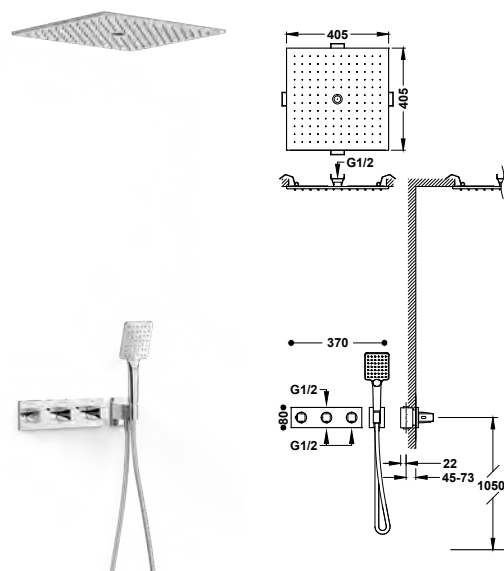

**B-system 3-way concealed thermostatic shower mixer tap kit**

- Concealed thermostatic body for horizontal installation included.
- Flow regulator and 3-way distributor.
- Square-round handle.
- Stainless steel concealed ceiling-mounted shower head with 2 stream types (rain/free flow). 405x405 mm.
- Wall-mounted support for hand shower with water supply.
- Anti-limescale hand showers: 96x110 mm. (3 stream types).
- Satin hose.

**Kit di miscelatore termostatico a incasso 3 getti B-system per doccia**

- Corpo termostatico a incasso con installazione orizzontale inclusa.
- Regolatore di flusso ed erogatore a 3 getti.
- Manopola quadrata-rotonda.
- Soffione doccia a incasso da soffitto in acciaio inossidabile con 2 tipi di getto (pioggia/free flow). 405x405 mm.
- Supporto per doccia con presa d'acqua a muro.
- Doccino anticalcare: 96x110 mm. (3 tipi di getto).
- Flessibile satinato.



30725306	1543 .-
30725306NM	2392 .-
30725306AC	2392 .-
30725306OR	3086 .-
30725306OM	3086 .-
30725306OP	3086 .-
30725306OPM	3086 .-

# THERM-BOX



Therm-box is the concealed system from Tres for thermostatic shower taps. Total temperature control with a compact design. You can purchase the concealed box and the visible part separately, making it easier to plan your project and saving you time.

*Therm-box è il sistema da incasso di Tres per i rubinetti doccia termostatici. Controllo totale della temperatura in un design compatto. La scatola da incasso e la parte a vista sono acquistabili separatamente, in questo modo la pianificazione del lavoro risulta semplificata ed efficiente.*



The visible parts are not too long, so you gain extra usable space inside the shower.

*I pezzi mostrati hanno una profondità ridotta, permettendo di guadagnare più spazio utilizzabile all'interno della doccia.*



Temperature control with a safety push button that limits the temperature to 38°C.

*Controllo della temperatura con pulsante di sicurezza che limita la temperatura a 38°C.*



Change between the two different water outlets by just turning the distributor.

*Con una semplice rotazione del distributore è possibile passare da una all'altra uscita dell'acqua disponibili.*



The Therm-box insulates the brass body from heat transfer to the wall, and being watertight, prevents water from filtering through the wall in the event of a leak.

*La scatola Therm-box isola la trasmissione di temperatura del corpo in ottone verso la parete. Essendo a tenuta stagna impedisce all'acqua di penetrare attraverso la parete in caso di perdite.*



The waterproof seal prevents damp.

*La giunzione impermeabile previene l'umidità.*



The dampers prevent noise transmission from the tap to the wall and piping.

*Gli ammortizzatori impediscono la trasmissione del rumore del rubinetto alla parete e ai tubi.*



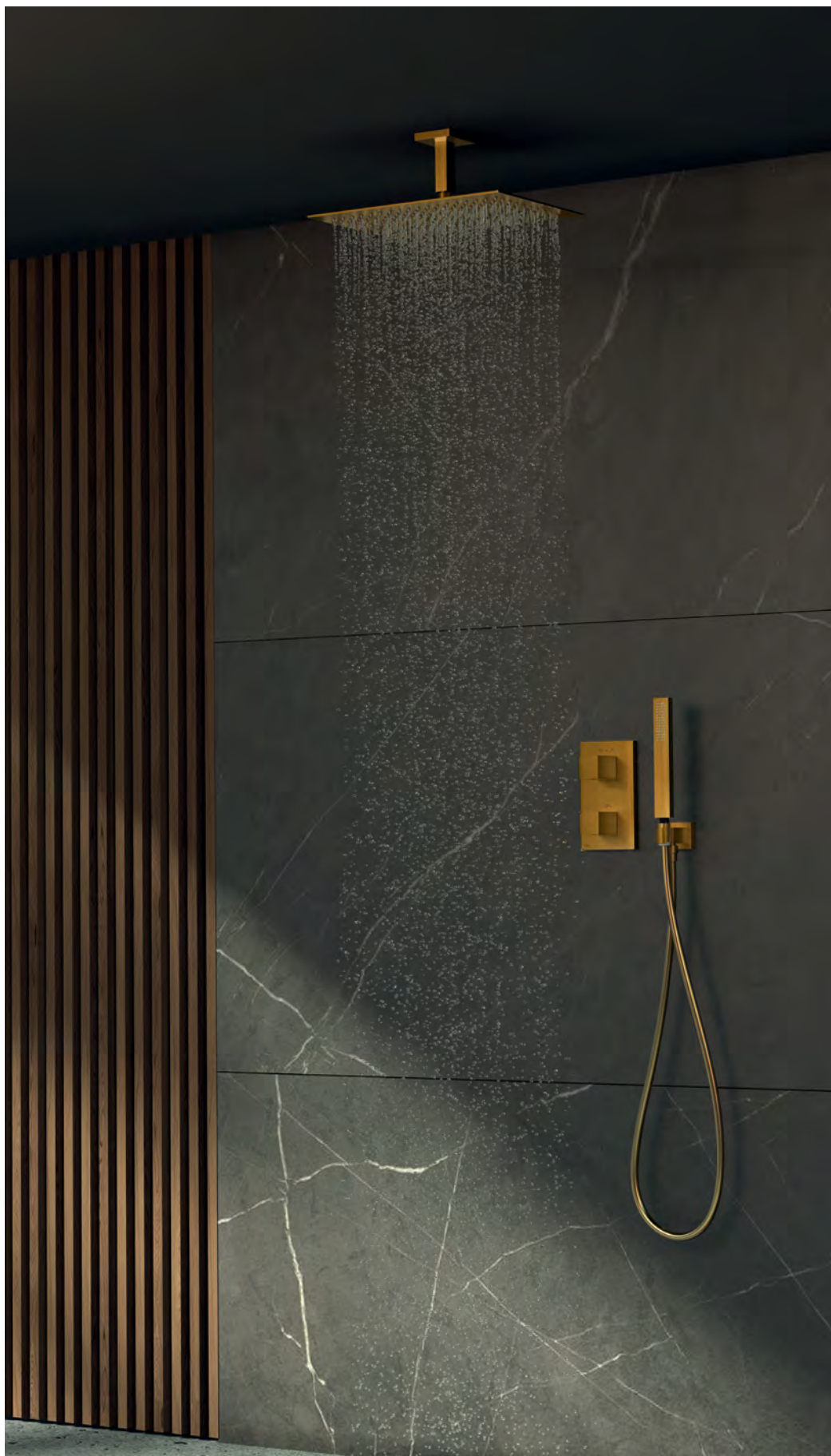

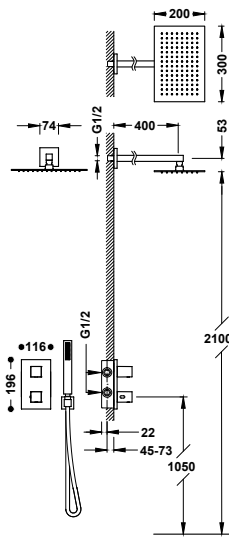

### Therm-Box 2-way concealed thermostatic tap kit for showers

- Concealed body included.
- Square handle with temperature control. 2-way ceramic distributor.
- Wall-mounted arm with adjustable stainless steel shower head: 300x200 mm.
- Wall-mounted support for hand shower with water supply.
- Anti-limescale brass hand shower.
- Satin hose.

### Kit di miscelatore termostatico da incasso a 2 getti Therm-box per doccia

- Corpo a incasso incluso.
- Manopola quadrata con controllo della temperatura. Erogatore in ceramica a 2 getti.
- Braccio a muro con soffione doccia orientabile in acciaio inossidabile: 300x200 mm.
- Supporto per doccia con presa d'acqua a muro.
- Doccino anticalcare in ottone.
- Flessibile satinato.



■ 20225054	659 .-
■ 20225054NM	1021 .-
■ 20225054BM	1021 .-
■ 20225054AC	1021 .-
■ 20225054OR	1318 .-
■ 20225054OM	1318 .-

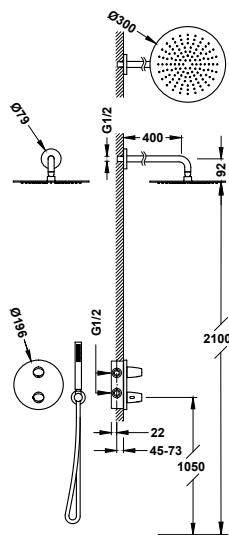

### Therm-Box 2-way concealed thermostatic tap kit for showers

- Concealed body included.
- Oval handle with temperature control. 2-way ceramic distributor.
- Wall-mounted arm with adjustable stainless steel shower head: Ø 300 mm.
- Wall-mounted support for hand shower with water supply.
- Anti-limescale brass hand shower.
- Satin hose.

### Kit di miscelatore termostatico da incasso a 2 getti Therm-box per doccia

- Corpo a incasso incluso.
- Manopola ovale con controllo della temperatura. Erogatore in ceramica a 2 getti.
- Braccio a muro con soffione doccia orientabile in acciaio inossidabile: Ø 300 mm.
- Supporto per doccia con presa d'acqua a muro.
- Doccino anticalcare in ottone.
- Flessibile satinato.



■ 28125004	551 .-
■ 28125004NM	854 .-
■ 28125004AC	854 .-

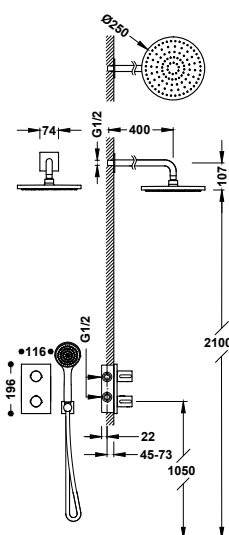

### Therm-Box 2-way concealed thermostatic tap kit for showers

- Concealed body included.
- ABS round handle with temperature control. 2-way ceramic distributor.
- Wall-mounted arm with adjustable shower head: Ø 250 mm.
- Wall-mounted support for hand shower with water supply.
- Anti-limescale hand shower.
- Metal hose.

### Kit di miscelatore termostatico da incasso a 2 getti Therm-box per doccia

- Corpo a incasso incluso.
- Manopola rotonda in ABS con controllo della temperatura. Erogatore in ceramica a 2 getti.
- Braccio a muro con soffione doccia orientabile: Ø 250 mm.
- Supporto per doccia con presa d'acqua a muro.
- Doccino anticalcare.
- Flessibile in metallo.



■ 21625004	405 .-
------------	--------

# SHOWER TECHNOLOGY





Fitting your bath or shower with Shower technology will bring you nothing but joy. Tres has updated its electronic innovation to give you absolute control in the shower. The shower is at the user's disposal with new capacities that increase safety, water savings and convenience when showering, with everything ready and waiting.

*Dotare la doccia o la vasca da bagno di Shower Technology sarà una vera soddisfazione. Tres ha migliorato l'innovazione elettronica per avere un controllo assoluto della doccia. La doccia è al servizio dell'utente in quanto integra nuove funzionalità per aumentarne la sicurezza, risparmiare acqua e avere la comodità di fare la doccia quando tutto è pronto.*

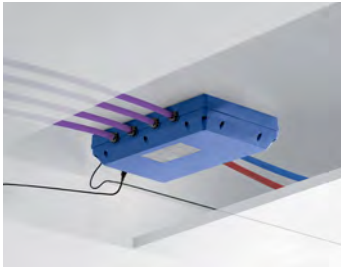

The electronic thermostatic control unit can be installed up to a maximum distance of 10 metres from the control screen.

*La centralina termostatica elettronica può essere installata fino ad un massimo di 10 metri di distanza dal display di controllo.*



Totally waterproof and anti-humidity built-in system with Schlüter seals.

*Sistema incassato, totalmente a tenuta stagna e anti-umidità con giunti Schlüter.*



The control screen is fully watertight, with illuminated operating buttons.

*Il pannello di controllo è completamente impermeabile, con i pulsanti di comando illuminati.*



The temperature is at 38°C when the tap is initially turned on. The maximum limit is 46°C. The selected temperature level is indicated by numbers and a color scale.

*Quando viene aperto inizialmente, la temperatura è di 38°C. Il limite massimo è di 46°C. Il livello della temperatura selezionata verrà indicato numericamente e con una scala di colori.*



The tap stops when it reaches the programmed temperature and the shower is ready for you to enter whenever you like.

*Il rubinetto si chiude quando viene raggiunta la temperatura programmata e la doccia è pronta al tuo ingresso.*



Includes a program to prevent legionella (5 minutes at 60°C), or to disinfect directly (10 minutes at 60°C).

*Dotato di un programma per prevenire la legionella (5 minuti a 60°C) o direttamente per disinfettare (10 minuti a 60°C).*





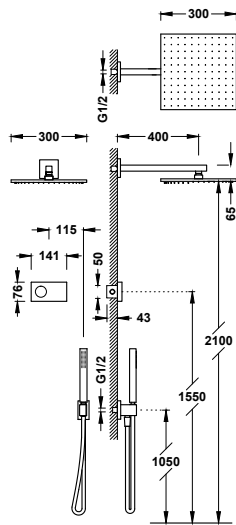

### Shower Technology Blue Edition 2-way concealed electronic thermostatic shower tap kit

- White electronic control included with Schlüter anti-moisture seals.
- Electronic thermostatic control box included (2-way).
- Wall-mounted arm with adjustable stainless steel shower head: 300x300 mm.
- Wall-mounted support for hand shower with water supply.
- Anti-limescale brass hand shower.
- Satin hose.

09286563	1183 .-
092865630M	1585 .-
092865630PM	1858 .-
09288563NM	1282 .-

### Kit di miscelatore termostatico elettronico a incasso 2 getti Shower Technology Blue Edition per doccia

- Controllo elettronico bianco incluso con guarnizioni antiumidità Schlüter.
- Centralina elettronica termostatica inclusa (2 getti).
- Braccio a muro con soffione doccia orientabile in acciaio inossidabile: 300x300 mm.
- Supporto per doccia con presa d'acqua a muro.
- Doccino anticalcare in ottone.
- Flessibile satinato.

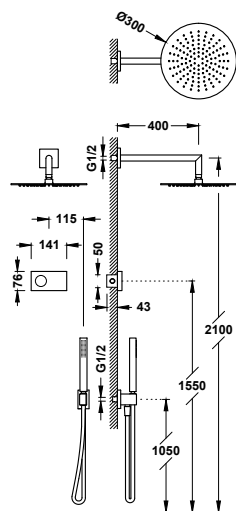

### Shower Technology Blue Edition 2-way concealed electronic thermostatic shower tap kit

- White electronic control included with Schlüter anti-moisture seals.
- Electronic thermostatic control box included (2-way).
- Wall-mounted arm with adjustable stainless steel shower head: Ø 300 mm.
- Wall-mounted support for hand shower with water supply.
- Anti-limescale brass hand shower.
- Satin hose.

09286558	1138 .-
092865580M	1529 .-
092865580PM	1529 .-
09288558NM	1239 .-

### Kit di miscelatore termostatico elettronico a incasso 2 getti Shower Technology Blue Edition per doccia

- Controllo elettronico bianco incluso con guarnizioni antiumidità Schlüter.
- Centralina elettronica termostatica inclusa (2 getti).
- Braccio a muro con soffione doccia orientabile in acciaio inossidabile: Ø 300 mm.
- Supporto per doccia con presa d'acqua a muro.
- Doccino anticalcare in ottone.
- Flessibile satinato.

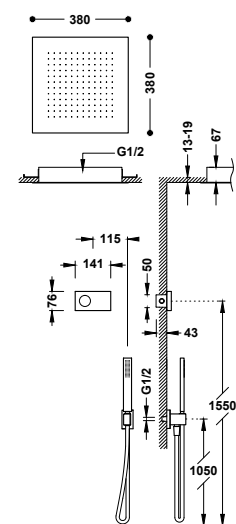

### Shower Technology Blue Edition 2-way concealed electronic thermostatic shower tap kit

- White electronic control included with Schlüter anti-moisture seals.
- Electronic thermostatic control box included (2-way).
- Concealed stainless steel ceiling-mounted shower head: 380x380 mm.
- Wall-mounted support for hand shower with water supply.
- Anti-limescale brass hand shower.
- Satin hose.

09286552	1540 .-
09288552NM	1952 .-

### Kit di miscelatore termostatico elettronico a incasso 2 getti Shower Technology Blue Edition per doccia

- Controllo elettronico bianco incluso con guarnizioni antiumidità Schlüter.
- Centralina elettronica termostatica inclusa (2 getti).
- Soffione doccia soffitto a incasso in acciaio inossidabile: 380x380 mm.
- Supporto per doccia con presa d'acqua a muro.
- Doccino anticalcare in ottone.
- Flessibile satinato.



NEW COLLECTIONS

*NUOVE COLLEZIONI*



# MONT BLANC





The Mont Blanc collection by Tres is based on a symmetrical architecture, built on the premises of design, functionality and attention to detail. With the characteristic cross-shaped handles, this update of the classic design allows more adaptability and turns the pieces into something timeless and authentic.

*La collezione Mont Blanc di Tres si basa su un'architettura simmetrica costruita sulle premesse di design, funzionalità e attenzione ai dettagli. Con le caratteristiche manopole a forma di croce, questa revisione dell'estetica classica permette una maggiore adattabilità e rende i tuoi pezzi senza tempo e autentici.*







			
■ 28310301      225.-	■ 28320301      240.-	■ 28380301      280.-	■ 28310501      300.-
■ 28310301NM    349.-	■ 28320301NM    372.-	■ 28380301NM    434.-	■ 28310501NM    465.-
■ 28310301AC    349.-	■ 28320301AC    372.-	■ 28380301AC    434.-	■ 28310501AC    465.-
■ 28310301OM    450.-	■ 28320301OM    480.-	■ 28380301OM    560.-	■ 28310501OM    600.-
■ 28310301OPM   450.-	■ 28320301OPM   480.-	■ 28380301OPM   560.-	■ 28310501OPM   600.-

		
■ 28330001      275.-	■ 28330002      285.-	■ 28312001      228.-
■ 28330001NM    426.-	■ 28330002NM    442.-	■ 28312001NM    353.-
■ 28330001AC    426.-	■ 28330002AC    442.-	■ 28312001AC    353.-
■ 28330001OM    550.-	■ 28330002OM    570.-	■ 28312001OM    456.-
■ 28330001OPM   550.-	■ 28330002OPM   570.-	■ 28312001OPM   456.-



	
■ 28316301 320.-	■ 28317601 385.-
■ 28316301NM 496.-	■ 28317601NM 597.-
■ 28316301AC 496.-	■ 28317601AC 597.-
■ 28316301OM 640.-	■ 28317601OM 770.-
■ 28316301OPM 640.-	■ 28317601OPM 770.-

	
■ 28319401 550.-	■ 28325001 170.-
■ 28319401NM 853.-	■ 28325001NM 264.-
■ 28319401AC 853.-	■ 28325001AC 264.-
■ 28319401OM 1100.-	■ 28325001OM 340.-
■ 28319401OPM 1100.-	■ 28325001OPM 340.-



# FUJI



The conical shapes of the Fuji collection from Tres are represented in each of the pieces. Its twisty silhouette is what achieves this dynamic effect that is so attractive for modern bathrooms, elevating the presence and visibility of each tap.

*Le forme coniche della collezione Fuji de Tres sono rappresentate in ognuno dei pezzi. La loro silhouette sinuosa raggiunge questo dinamismo così attraente per i bagni moderni e aumenta la visibilità e la presenza di ogni rubinetto.*



				
■ 28110301      115.-	■ 28110401      123.-	■ 28190301      119.-	■ 28110402      127.-	■ 28120301      225.-
■ 28110301NM    178.-	■ 28110401NM    191.-	■ 28190301NM    184.-	■ 28110402NM    197.-	■ 28120301NM    349.-
■ 28110301AC    178.-	■ 28110401AC    191.-	■ 28190301AC    184.-	■ 28110402AC    197.-	■ 28120301AC    349.-

				
■ 28180301      260.-	■ 28144701      200.-	■ 28164701      210.-	■ 28184701      225.-	■ 28130001      230.-
■ 28180301NM    403.-	■ 28144701NM    310.-	■ 28164701NM    326.-	■ 28184701NM    349.-	■ 28130001NM    357.-
■ 28180301AC    403.-	■ 28144701AC    310.-	■ 28164701AC    326.-	■ 28184701AC    349.-	■ 28130001AC    357.-





■ 28130002	240.-
■ 28130002NM	372.-
■ 28130002AC	372.-



■ 28130003	270.-
■ 28130003NM	419.-
■ 28130003AC	419.-



■ 28130004	280.-
■ 28130004NM	434.-
■ 28130004AC	434.-



■ 28112001	122.-
■ 28112001NM	189.-
■ 28112001AC	189.-



■ 28112301	180.-
■ 28112301NM	279.-
■ 28112301AC	279.-



■ 28116701	230.-
■ 28116701NM	357.-
■ 28116701AC	357.-



■ 28117001	250.-
■ 28117001NM	388.-
■ 28117001AC	388.-



■ 28119101	473.-
■ 28119101NM	733.-
■ 28119101AC	733.-



■ 28119701	503.-
■ 28119701NM	780.-
■ 28119701AC	780.-



■ 28128004	446.-
■ 28128004NM	691.-
■ 28128004AC	691.-



Low energy consumption system in which the tap is always opened with cold water, avoiding unnecessary switching on of the heater.

*Sistema a basso consumo energetico in cui il rubinetto si apre sempre con acqua fredda, evitando inutili accensioni dello scaldabagno.*



Water saving system with a two-position handle. The middle position allows for a 50% water saving.

*Sistema a basso consumo d'acqua con apertura del rubinetto in due posizioni. Nella posizione intermedia, si consuma il 50% dell'acqua.*



Adjustable aerator with 5.7 l/min flow rate limiter for a 50% lower water consumption compared to normal taps, while maintaining maximum comfort.

*Aeratore regolabile con limitatore di flusso a 5,7 lpm, per consumare meno del 50% di acqua rispetto ai normali rubinetti, mantenendo un utilizzo comodo.*



The side handle for high washbasins is at a suitable height for comfortable use without it touching the washbasin.

*La maniglia laterale per lavabi alti si trova a un'altezza adeguata per un uso confortevole senza urti contro il lavabo.*



In wall-mounted shower units, you can switch between the two available water outlets by simply turning the control knob.

*Nei kit a muro per la doccia, con una semplice rotazione dell'erogatore è possibile passare da un getto dell'acqua all'altro.*



# TRÈS

[www.tresgriferia.com](http://www.tresgriferia.com)

C/ Penedès, 16-26  
Zona Industrial, Sector A  
08759 Vallirana (Barcelona)

[comercial@tresgriferia.com](mailto:comercial@tresgriferia.com)  
+34 93 683 40 27

Designed and produced in **Barcelona**